



EZTrayTM

Cable Management Made Easy



PRESENTATION

| | |
|--|-----|
| Introduction: | 3 |
| EZ Tray: The Tray That Saves You Time! | 4-5 |
| EZ Tray: The Innovative Cable Management Solution. | 6-7 |
| EZ Tray Adapts to Any Installation Easily | 8-9 |



SELECTION & ORDERING INFORMATION

| | |
|--|-------|
| EZ Tray Straight Sections | 10-11 |
| Splicing / Standard Support Systems. | 12-13 |
| The FAS System: An Easy Way to Install Cable Trays | 14-15 |
| Other EZ Ways to Install EZ Tray. | 16-17 |



CABLE TRAY INSTALLATION

| | |
|--|-------|
| How to Cut EZ Tray. | 18-19 |
| It's EZ to Form Bends! | 20-21 |
| It's EZ to Form Elbows! | 22-23 |
| It's EZ to Form Tees | 24-25 |
| It's EZ to Form Reductions and Change Levels | 26-27 |



EZ Tray—Cable Management Made Easy!

Easy to Install. . .Easy to handle. . .Easy to Adapt.

The **EZ Tray** system is the revolutionary cable tray system constructed of precision engineered, high quality, welded steel wire. The **EZ Tray** system includes everything required to make installation effortless—and it adapts easily as your cable management needs grow and change.

This unique system was invented by the recognized global leader in cable management solutions—Métal Déployé—the parent company of Cablofil, Inc. For decades, this product has been providing effective, efficient and innovative cable management solutions throughout the world.

Designed to save you time, the **EZ Tray** system is safe, durable and trouble-free. A comprehensive range of accessories allows for every possible installation configuration and makes any project fast and simple to complete.

The **EZ Tray** system can help you create the right cable management system right from the start. Our staff of professional technical representatives are available to assist project design, system specifications and a simplified ordering process.

Take advantage of cable management made easy...with **EZ Tray**.



EZ Tray™

EZ TRAY: THE TRAY THAT SAVES YOU TIME!

Just cut, bend and install! It's that easy! It's that fast!

- **EZ to order!**
Trays come in easy to order 10' lengths.
- **EZ to handle!**
It's lightweight design makes it easy to handle, carry and install.
- **EZ to install!**
Our exclusive Fast Assembly System (FAS) does not require screws or nuts.
- **One tray fits all!**
The **EZ Tray** system can be mounted in any kind of installation and formed in any configuration.
- **It's strong and stable!**
Constructed from high strength steel wires designed to support a large volume of cables.
- **The EZ Tray system is safe!**
The unique "T" weld safety edge eliminates sharp edges—avoiding injury to hands and damage to cable.





EZ TRAY: THE TRAY THAT SAVES YOU TIME!



EZ to change! EZ to upgrade!

- You can cut, branch and create any configuration you need!
- Reduces component costs!
Fewer components are required—saves you time, saves you money!
- Reduces downtime.
You don't have to wait for additional component parts.
- No waste of materials!
Even cut trays can be re-used.
- Unique mesh design makes cable "drop-in and drop-out" easy.
- The **EZ Tray** system is so versatile, it makes project planning easy! Allows you to make modifications or expansions easily and economically.





EZ TrayTM

EZ TRAY: THE INNOVATIVE CABLE MANAGEMENT SOLUTION

MORE THAN 25,000 MILES INSTALLED WORLDWIDE!

Strong.

EZ Tray cable trays are made of high mechanical strength steel wires and is designed to perform with a full volume capacity load of cables. It's unique mesh structure exhibits load characteristics similar to a "net" rather than a beam. For loading questions call Cablofil, Inc.

The unique mesh design of the tray does not fail as a beam would fail if it is overloaded.

A steady and balanced cable support system!

The **EZ Tray** system is a balanced system that's easy to install. Even when loads are unbalanced the tray won't twist.

Compatible with strut channel framing. No training required for installation.

The **EZ Tray** system is fully compatible with any strut channel. The system installs as easily as strut channels eliminating the time it would take to re-train installers.

Corrosion resistant!

EZ Tray cable trays are electroplated with zinc making them ideal for most indoor applications and even in some mild outdoor environments. The 12 μ zinc coating resists corrosion and enhances wire life.

Strict quality procedures and quality control throughout production.

Cablofil, Inc. is dedicated to customer satisfaction and quality. From raw materials to final delivery, strict quality procedures and checks are inherent throughout the manufacturing process. We are fully ISO 9002 quality certified by the AFAQ (French Institute of Quality) as well as other independent quality certification programs including BDE, E90, UL and DET NORSKE VERITAS.

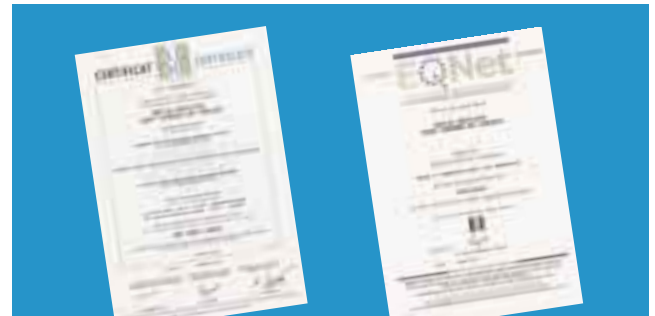

ISO 9002





EZ TRAY: THE INNOVATIVE CABLE MANAGEMENT SOLUTION

MORE THAN 25,000 MILES INSTALLED WORLDWIDE!

Classified by Underwriters Laboratories, Inc.

The following straight sections of **EZ Tray** cable trays are classified by Underwriters Laboratories, Inc.

- CF 54-200 (2" Deep x 8" Wide)
- CF 54-300 (2" Deep x 12" Wide)
- CF 54-450 (2" Deep x 18" Wide)

Representative samples of this product have been evaluated by UL and meet applicable UL Standards and requirements.

Carbon Steel **EZ Tray** cable trays were tested for suitability as an equipment ground conductor. One of the following splicing methods must be used:

- ED 275 EZ & CE 25 EZ (Flat bar w/clip assemblies)
- EDT EZ & CE 25 EZ (Formed plate w/clip assemblies)
- CE 30 & CE 25 EZ (Clip assemblies)

Field fabrication can reduce the cross sectional area of the **EZ Tray** system and may not meet the ground conductor requirements. Bonding jumpers may be used in conjunction with the **EZ Tray** system, however, to facilitate conductor needs.



View of sensors

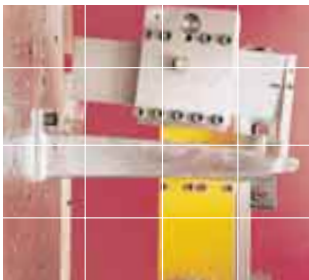

Bracket testing machine



Cable tray testing machine



Certification of CABLOFIL according to Standard E90



EZ Tray™

EZ TRAY ADAPTS TO ANY INSTALLATION EASILY

With the flexible EZ Tray system, installation is adaptable and easy to upgrade.



Makes 90° bends



No extra parts required



Handles multiple levels



Adapts to any angle



EZ TRAY ADAPTS TO ANY INSTALLATION EASILY



Standard tees made easy

With the **EZ Tray** system you can create your own tees, elbows and risers right at the job site. Simply cut the wires of the cable tray to change existing configurations. Also, you can easily add additional levels of trays by connecting the new trays to existing ones. The **EZ Tray** system is so flexible it can fulfill your cable management needs today and adapt quickly to future requirements.



Reduced width for smaller applications



Easily changes levels



Large load volume













EZ TRAY STRAIGHT SECTIONS

Safe Trays:

- The special **Safe-T-Edge** protects installers from sharp wires while it prevents cables from fraying.
- The wire mesh is smooth and round to resist dirt and dust build-up.

Convenient Trays:

- Cable tray straight sections come in easy to handle standard 10' lengths.
- The large mesh size (2" wide by 4" long) offers numerous benefits! And, the size of the mesh allows cable installers to route cables in and out at any point without cutting the tray. The 1.5" to 2" high flange side of the tray prevents cables from falling off.
- For larger projects, **EZ Tray** can be special ordered with 4" depth (CF 105).

| PART # | DEPTH | | WIDTH | | WEIGHT PER PC. | | | |
|--|---|---|-------|-----|----------------|-------|-------|------|
| | in. | mm | in. | mm | lb | kg | | |
|  CF 30 | CF 30/100 EZ |  | 1.5" | 30 | 4" | 100 | 5.09 | 2.31 |
| | CF 30/300 EZ |  | 1.5" | 30 | 12" | 300 | 10.30 | 4.65 |
| | CF 54/50 EZ |  | 2" | 54 | 2" | 50 | 5.09 | 2.31 |
| | CF 54/100 EZ |  | 2" | 54 | 4" | 100 | 7.28 | 3.30 |
|  CF 54 | CF 54/150 EZ |  | 2" | 54 | 6" | 150 | 8.53 | 3.87 |
| | CF 54/200 EZ |  | 2" | 54 | 8" | 200 | 9.86 | 4.47 |
| | CF 54/300 EZ |  | 2" | 54 | 12" | 300 | 15.94 | 7.23 |
| | CF 54/450 EZ |  | 2" | 54 | 18" | 450 | 17.51 | 7.94 |
| CF 54/600 EZ |  | 2" | 54 | 24" | 600 | 34.50 | 15.51 | |



EZ TRAY STRAIGHT SECTIONS

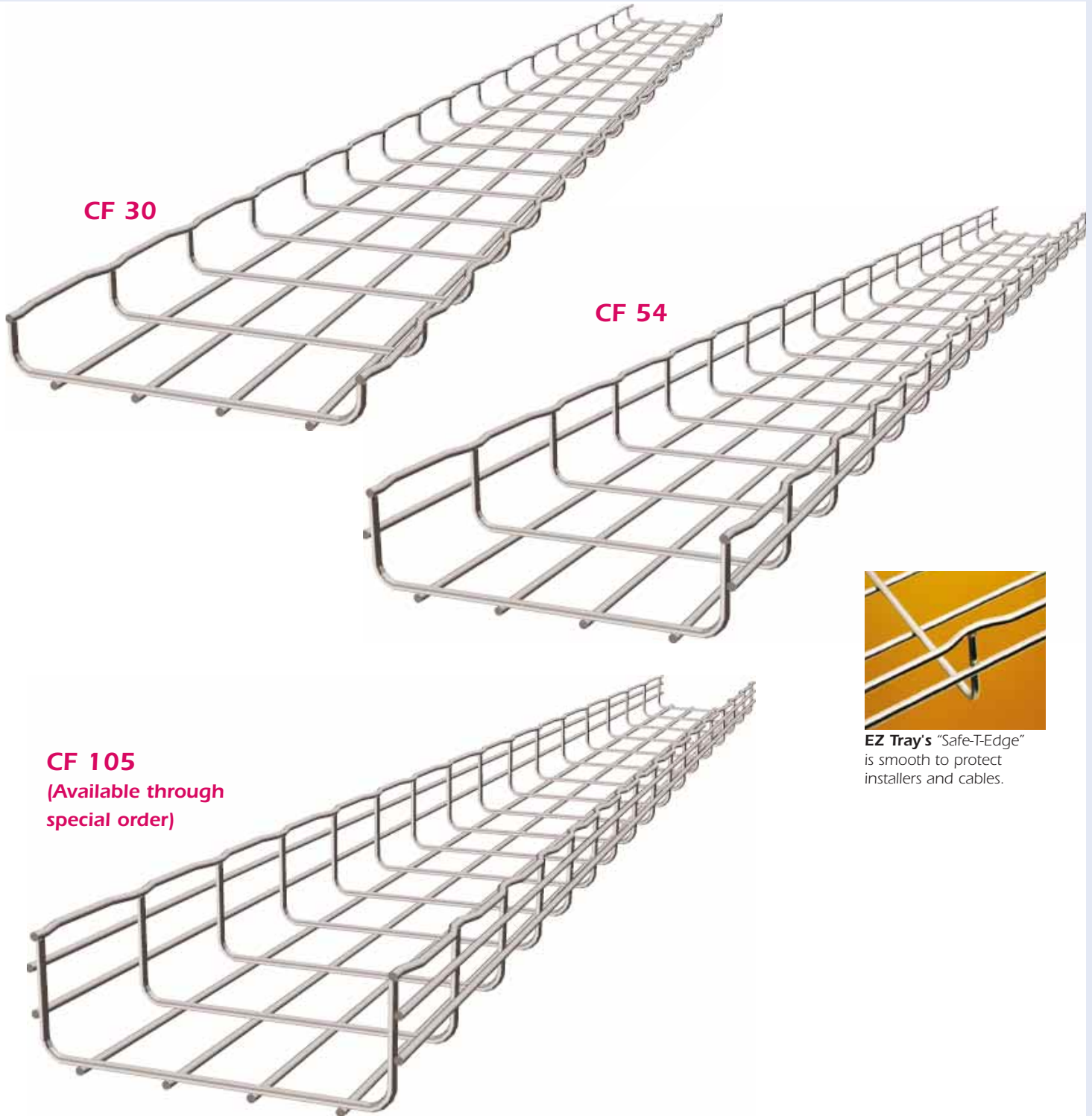

CF 30

CF 54

CF 105
(Available through special order)



EZ Tray's "Safe-T-Edge" is smooth to protect installers and cables.



SPLICING

Ideal for any installation cor

EDR Fast Splice.

The EDR is a fast and strong splice. It requires a special assembly tool which is contained in every bag of splices.

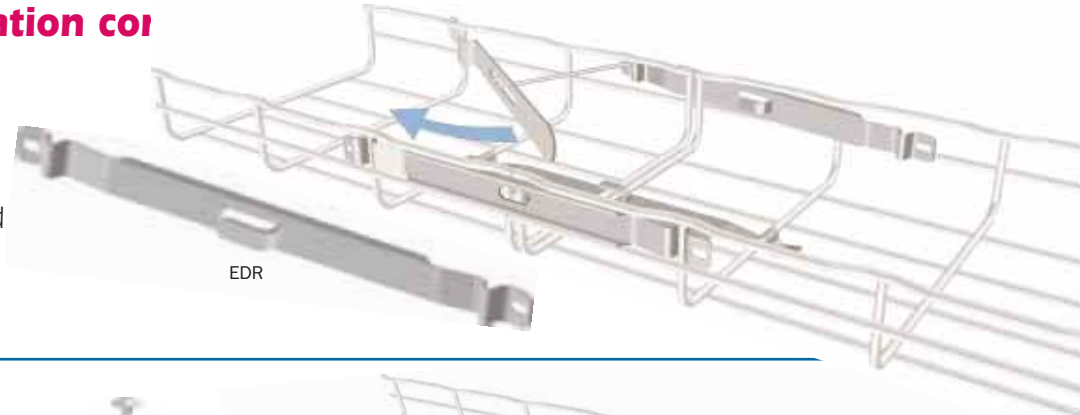

Nut/Bolt/Clamp Assembly

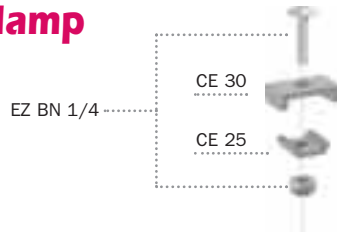

ED 275 Universal Splice Bar

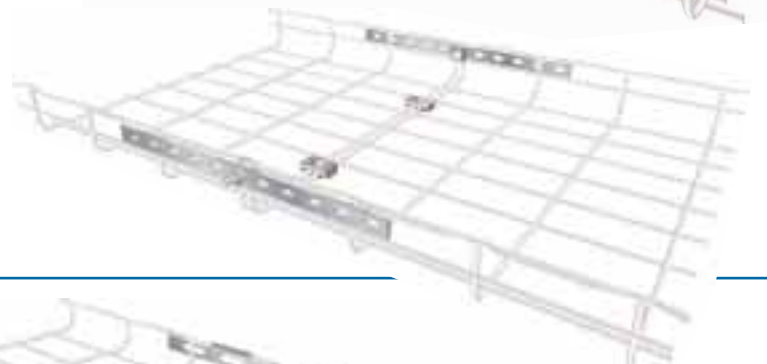
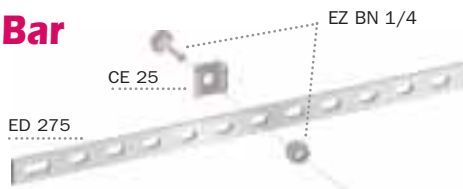

EDT Splice Assembly

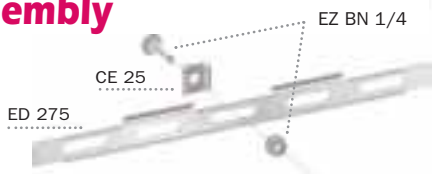

| PART # | DESCRIPTION | WEIGHT | | PACK QTY (IN PCS) |
|-----------|---|---------------|---------------|-------------------|
| | | lb | kg | |
| EZ BN 1/4 | Round head screws with square collar and serrated nut | 0.99 (50 pcs) | 0.45 (50 pcs) | 50 |
| ED 275 | 10" Universal Splice Bar | 0.277 | 0.126 | 50 |
| ED 1100 | 43" Universal Splice Bar | 1.100 | 0.500 | 1 |
| CE 25 | Square Splice Washer | 0.020 | 0.009 | 50 |
| CE 30 | Square Splice Washer | 0.033 | 0.015 | 50 |
| CE 40 | Square Splice Washer | 0.108 | 0.049 | 50 |
| EDR | Fast Splice | 0.150 | 0.068 | 50 |
| EDT | Splice Plate | 0.154 | 0.070 | 50 |



STANDARD SUPPORT SYSTEMS

CS Bracket

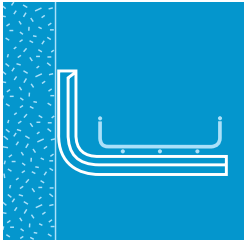

- For installations onto walls
- Recommended for use with tray widths up to 12"

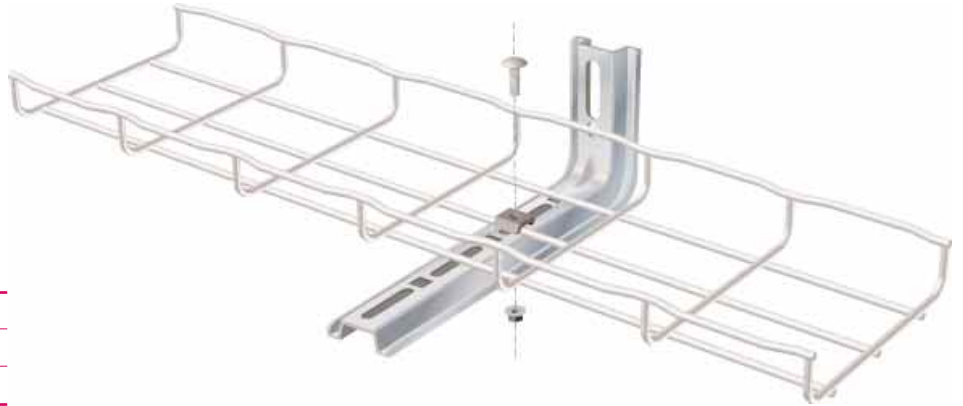

| PART # | LENGTH | |
|--------|--------|-----|
| | in. | mm |
| CS 100 | 4" | 110 |
| CS 200 | 8" | 210 |
| CS 300 | 12" | 310 |

CS Profile

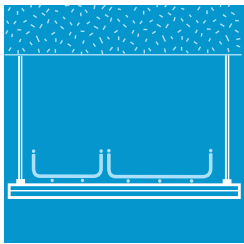

- For trapeze mounting to ceilings
- Use with tray widths up to 18"
- For widths up to 8", use 1 fastener
- For widths between 12" and 18", use 2 fasteners



| PART # | LENGTH | |
|-------------|--------|------|
| | in. | mm |
| PRO CS 1000 | 39" | 1000 |

CSC Bracket

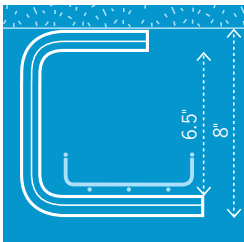

- For installation onto ceilings
- Use with tray widths up to 12"
- Use 1 fastener for widths up to 8"
- For 12" width use 2 fasteners



| PART # | LENGTH | |
|---------|--------|-----|
| | in. | mm |
| CSC 100 | 4" | 110 |
| CSC 200 | 8" | 210 |
| CSC 300 | 12" | 310 |



THE **FAS** SYSTEM: AN **EZ** WAY TO INSTALL CABLE TRAYS

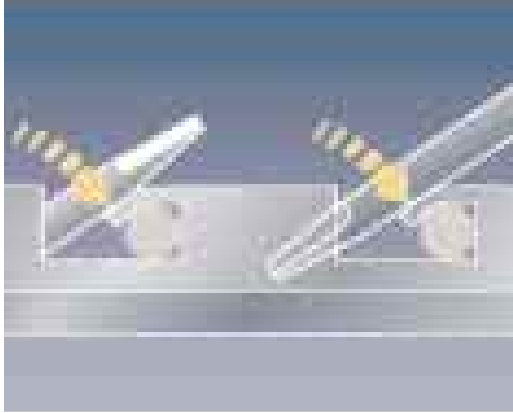

No need for screws, bolts, or other tools. Simply bend the anchoring tab on the wire...that's it!

Patent pending

The FAS System Difference:

- No screws, bolts or additional tools required
- Simply bend the anchoring tabs on the wire
- Reduced installation time
- Wide range of profiles and brackets
- Adapts easily to any cable system

FAS PROFILE

| PART # | LENGTH | | WEIGHT | |
|-----------|--------|------|--------|------|
| | in. | mm | lb | kg |
| FAS P200 | 8" | 200 | 0.51 | 0.23 |
| FAS P300 | 12" | 300 | 0.75 | 0.34 |
| FAS P400 | 16" | 400 | 0.99 | 0.45 |
| FAS P500 | 20" | 500 | 1.23 | 0.56 |
| FAS P1000 | 40" | 1000 | 2.49 | 1.13 |

FAS Profile

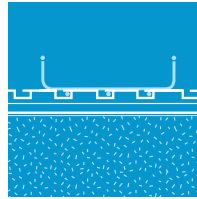

- For installing onto floors

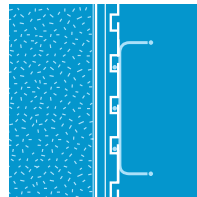

- For vertical installations on walls

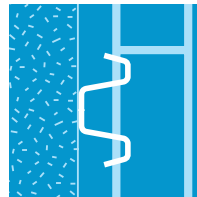

- For horizontal installations on walls





THE **FAS** SYSTEM: AN **EZ** WAY TO INSTALL CABLE TRAYS

FAS Universal Brackets

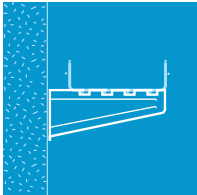

- Fully compatible with channel framing
- You can attach tray with bolt attachment or FAS System



| PART # | MAX. TRAY SIZE | | WEIGHT | |
|----------|----------------|-----|--------|-------|
| | in. | mm | lb | kg |
| FAS U100 | 4" | 100 | 0.244 | 0.111 |
| FAS U150 | 6" | 150 | 0.433 | 0.197 |
| FAS U200 | 8" | 200 | 0.563 | 0.256 |
| FAS U300 | 12" | 300 | 0.779 | 0.354 |
| FAS U400 | 18" | 450 | 1.660 | 0.753 |
| FAS U500 | 24" | 600 | 2.620 | 1.179 |

FAS C Brackets

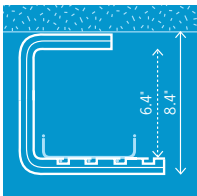

- For installing onto ceilings



| PART # | MAX. TRAY SIZE | | WEIGHT | |
|----------|----------------|-----|--------|------|
| | in. | mm | lb | kg |
| FAS C100 | 4" | 100 | 1.36 | 0.62 |
| FAS C200 | 8" | 200 | 1.65 | 0.75 |
| FAS C300 | 12" | 300 | 1.91 | 0.87 |

FAS L Brackets

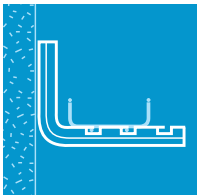

- For installing onto walls



| PART # | MAX. TRAY SIZE | | WEIGHT | |
|----------|----------------|-----|--------|------|
| | in. | mm | lb | kg |
| FAS L100 | 4" | 100 | 0.85 | 0.39 |
| FAS L200 | 8" | 200 | 1.14 | 0.52 |
| FAS L300 | 12" | 300 | 1.41 | 0.64 |



EZTray™

OTHER **EZ** WAYS TO INSTALL **EZ TRAY!**

AS — Trapeze Hanging Clip

EZ to add or remove cables!
No strut trapeze required!

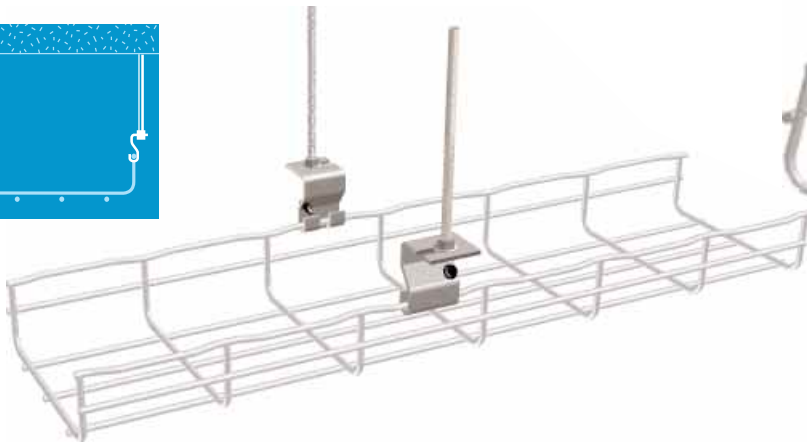
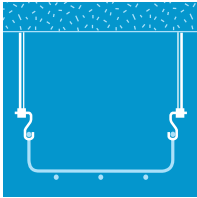

FAS Profile

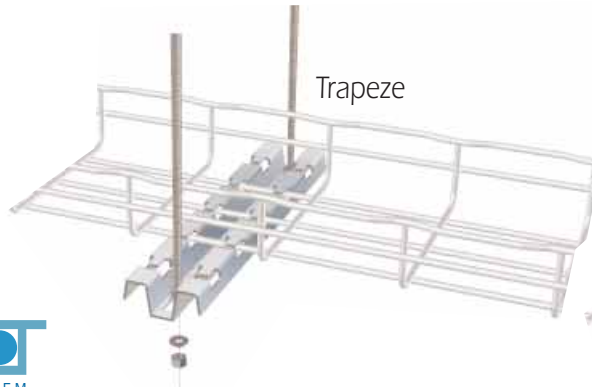
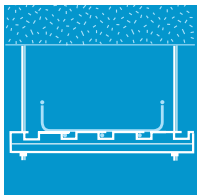

Trapeze

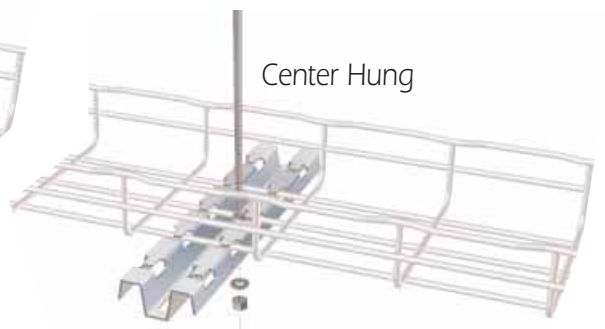

Center Hung

FAS

FAST ASSEMBLING SYSTEM
See page 14 for other FAS options.

UFS — Under Floor Support

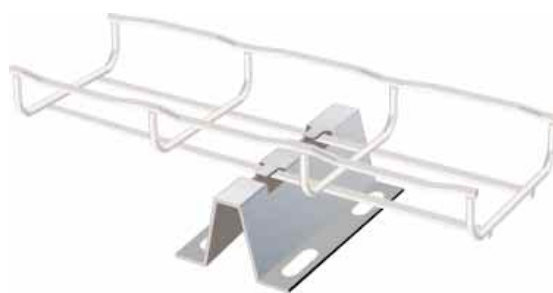
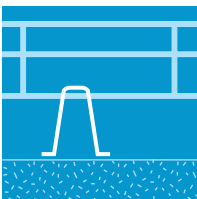

FAS

FAST ASSEMBLING SYSTEM



OTHER **EZ** WAYS TO INSTALL **EZ** TRAY!

SAS System — Single Hanger Bracket

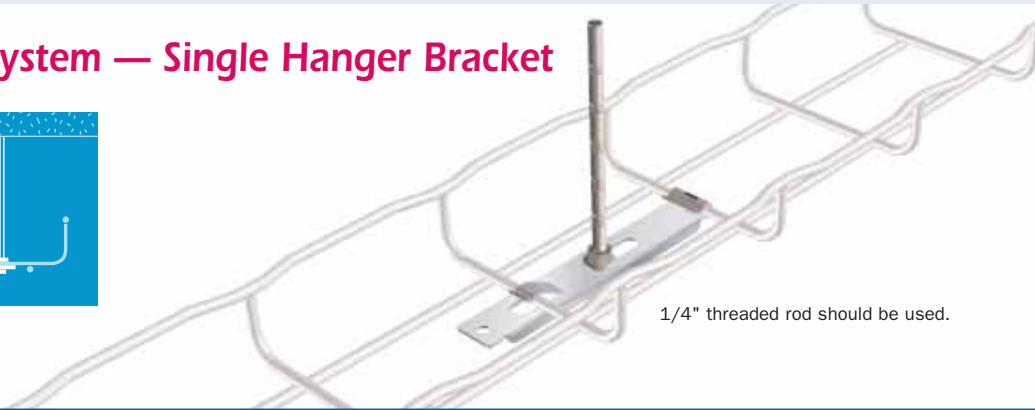
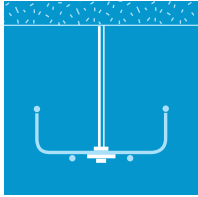

1/4" threaded rod should be used.

CAT — Snap in Wall Hanger Support

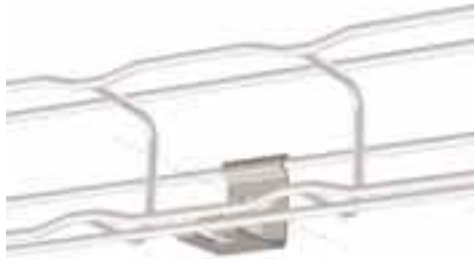
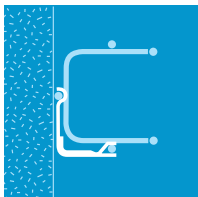

C50 — Wallmount Attachment

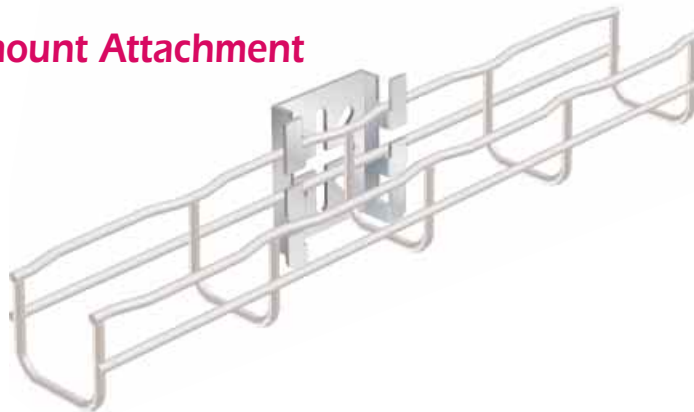
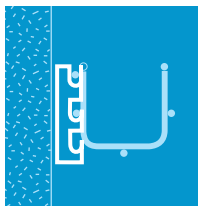

No screws required.
 Just crimp to connect.

ORDERING INFORMATION

| PART # | DESCRIPTION | MAX. TRAY SIZE | | WEIGHT | | PACK |
|--------|----------------------------------|----------------|-----|--------|------|------|
| | | in. | mm | lb | kg | QTY. |
| AS | Trapeze Hanging Clip | — | — | 0.110 | 0.06 | 50 |
| UFS | Under Floor Support Stand | — | — | 0.26 | 0.12 | 1 |
| SAS* | Single Hanger Suspension Bracket | 6" | 150 | 0.07 | 0.03 | 1 |
| CAT | Snap in Wall Hanger Support | 2" | 50 | 0.06 | 0.03 | 1 |
| C 50 | Wallmount Attachment | — | — | 0.22 | 0.10 | 1 |

*Only 1/4" threaded rod should be used.

U.S. dimensions are nominal



HOW TO CUT EZ TRAY

EZ Tray—Bend it, make tees, crosses or change levels—It's easy and can be done on the job site at a fraction of the cost of pre-formed equivalents.

Fewer, more flexible components mean:

- Reduced component costs
- Reduce delays—you can overcome unforeseen obstacles quickly
- Easier planning and estimating
- Reduced downtime—no waiting for unplanned components
- Complete flexibility—even cut trays can be re-used

Cutting EZ Tray is simple.

EZ Tray cable tray is cut on site to the exact measurements by cutting the steel wire with a side action bolt cutter. By following the illustrated cutting tips on these pages, clean and safe cuts are created that allow for a fast, economical installation. It is important to always use a side action bolt cutter when working with the **EZ Tray** system. It insures the integrity of the galvanic protective layer on the wire and helps create a galvanic couple to protect the new cut.

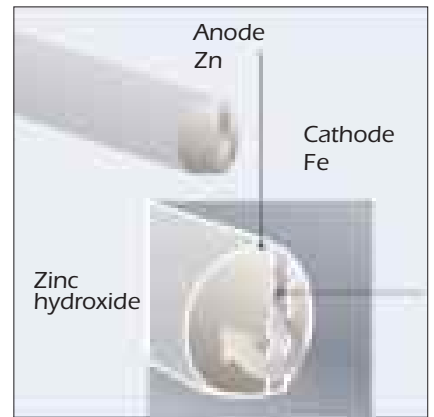
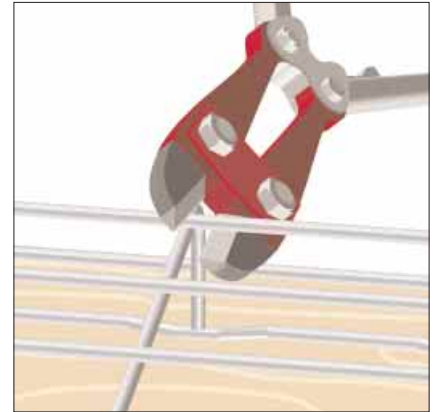

Galvanic protection



Position of the cutting jaws

Rest the jaws on the cradle wire and make the cut at an angle away from the new end.

ORDERING INFORMATION

| DESCRIPTION | WEIGHT | |
|-------------|--------|-----|
| | lb | kg |
| Bolt Cutter | 5.6 | 2.7 |

U.S. dimensions are nominal



HOW TO CUT EZ TRAY

How to cut EZ Tray's side wires.

- Always use side action bolt cutters
- Cut the top wire first, resting the lower jaw against the cradle wire
- Cut other side wires, from the underside of the tray, resting the lower jaw against the cradle wire
- Remember to angle all cuts away from the new end
- Cut each wire with one clean cut—eliminating any grinding or touch-up

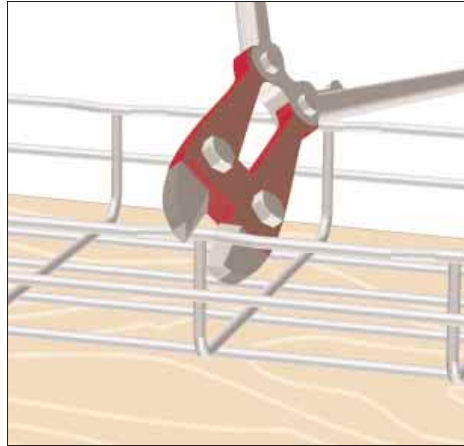

How to cut EZ Tray's bottom wires.

- Always use side action bolt cutters
- Cut all bottom wires in order (see illus.)
- Always cut from the underside of the tray
- Rest the lower jaw of the cutters against the cradle wire and cut at an angle away from the new end
- Cut each wire with one clean cut—eliminating any grinding or touch-up

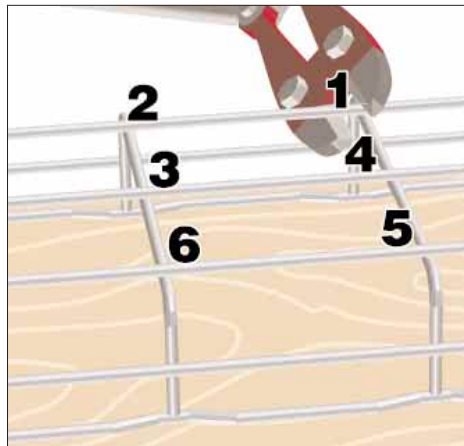

The finished cut is safe and ready for installation.

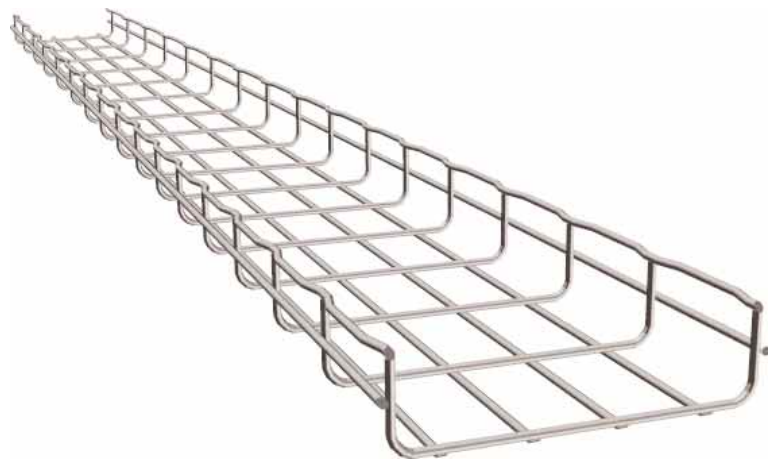



IT'S **EZ** TO FORM BENDS!

To form 90° bends in the tray, cut these wires according to width of tray

1. Cut the bottom & side wires

Bends can be formed easily on site by cutting the bottom and side wires. The shaded areas indicated should be cut and removed. Then, simply bend **EZ Tray** cable tray to form a 90° angle and you're ready to install. Make sure you use the appropriate hardware.

2" / 50 mm



4" / 100 mm



6" / 150 mm

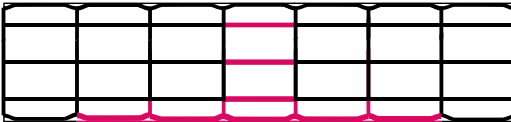

8" / 200 mm

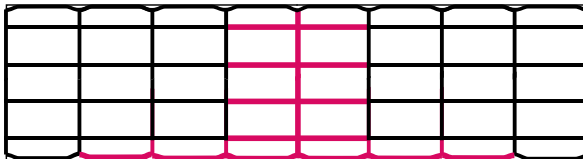

12" / 300 mm

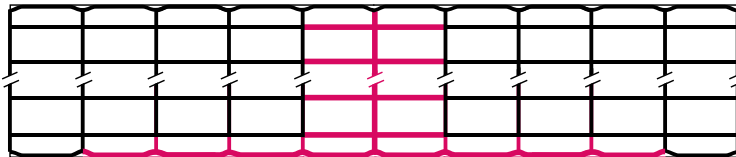

18" / 450 mm

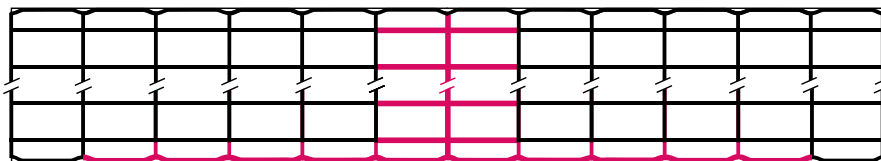

24" / 600 mm

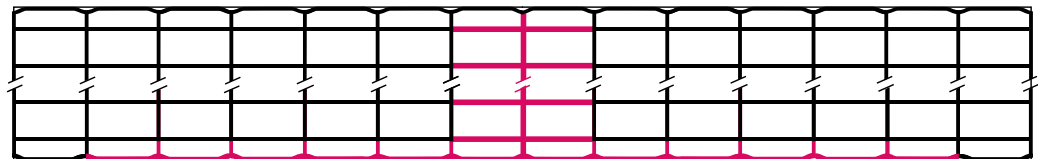



IT'S **EZ** TO FORM BENDS!

2. Assemble

**WIDTH 2"
50 mm**

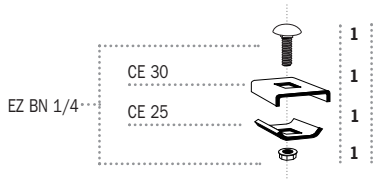
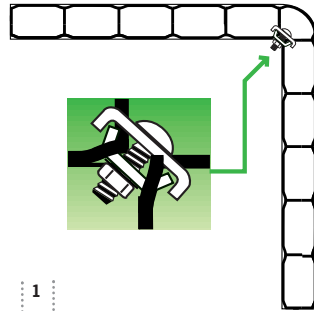

**WIDTH 4"
100 mm**

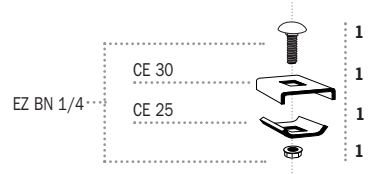
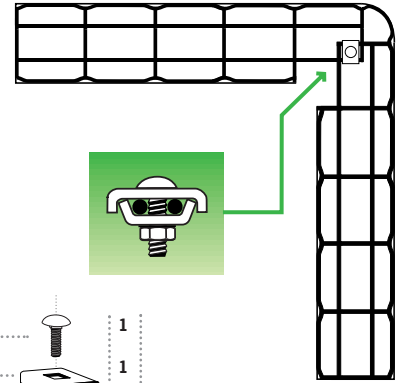

**WIDTH 6" to 24"
150 TO 600 mm**

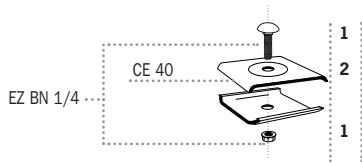
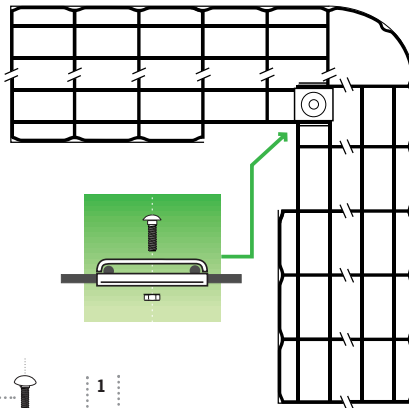

INTERNAL RADIUS AND SIZE OF THE SMALL RADIUS BENDS

| WIDTH OF TRAY | | RADIUS | | SIZE | |
|---------------|-----|--------|-----|------|-----|
| in. | mm | in. | mm | in. | mm |
| 4" | 100 | 6" | 145 | 15" | 375 |
| 6" | 150 | 5" | 120 | 17" | 430 |
| 8" | 200 | 5" | 120 | 17" | 430 |
| 12" | 300 | 5" | 120 | 21" | 530 |
| 18" | 450 | 5" | 120 | 25" | 630 |
| 24" | 600 | 5" | 120 | 29" | 730 |

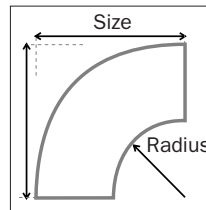



IT'S **EZ** TO FORM ELBOWS!

Cutting to form elbows by joining 2 trays:

1. Cut the side wires

EZ Tray cable trays can easily install to angles other than 90°. To form an elbow quickly and easily, cut and remove shaded area according to width. Connect the two pieces utilizing the **EZ Tray** system coupling hardware. The result is a sturdy and durable connection.

4" / 100 mm

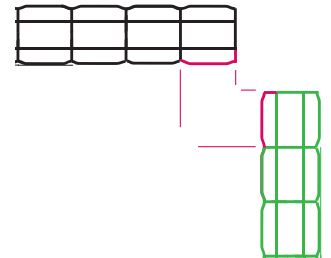

6" / 150 mm

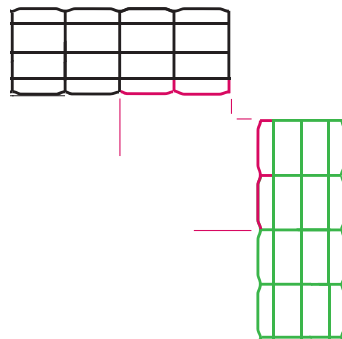

8" / 200 mm

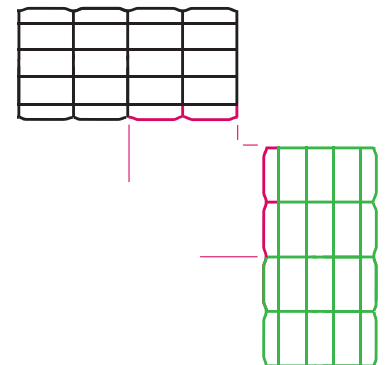

12" / 300 mm

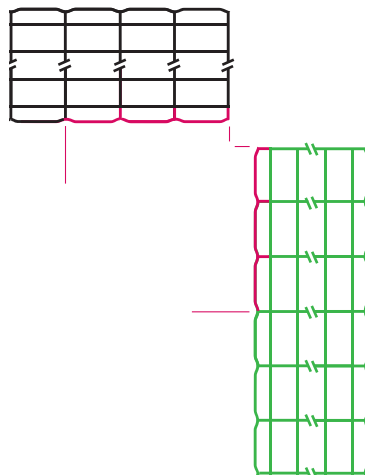

18" / 450 mm

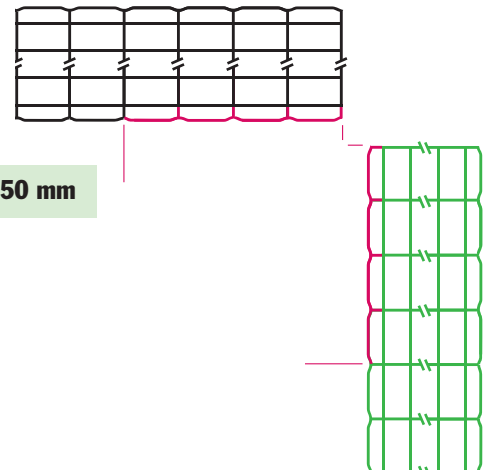

U.S. dimensions are nominal



IT'S **EZ** TO FORM ELBOWS!

2. Assemble

**WIDTH 2"
100 mm**

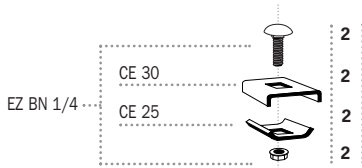
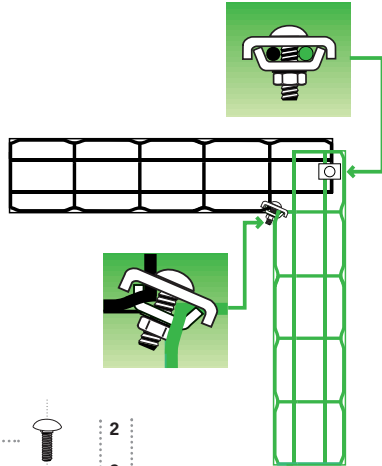

**WIDTH 6"
150 mm**

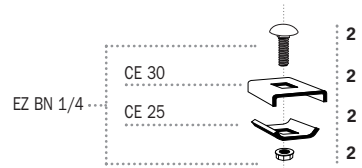
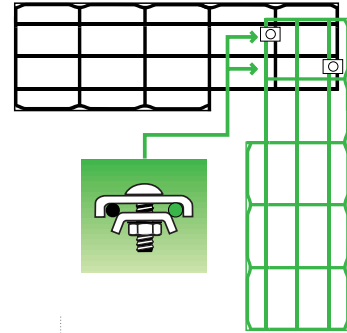

**WIDTH
8" to 18"
200 to 450 mm**

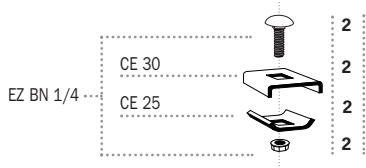
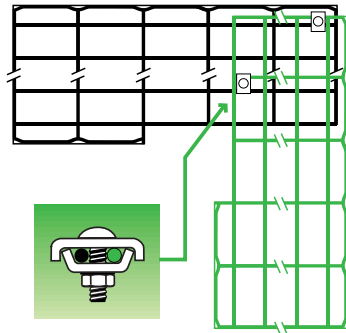

**ADJUSTABLE
ELBOWS**

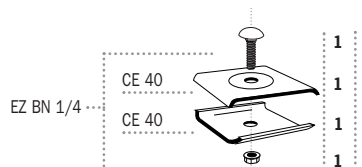
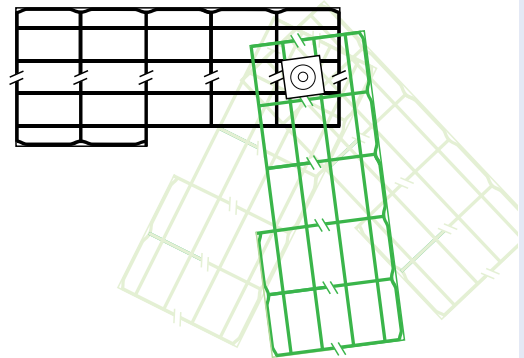

U.S. dimensions are nominal



IT'S EZ TO FORM TEES

To form tees with 90° junction

1. Cut the side wires

To form a standard tee connection, cut the shaded area as shown. Connect two pieces and secure the junction utilizing the EZ Tray system coupling hardware.

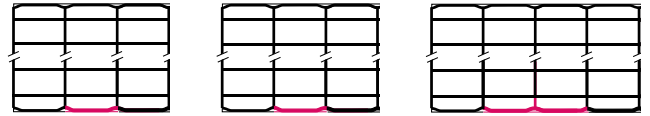

2" / 50 mm



4" / 100 mm

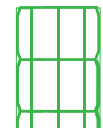

6" / 150 mm

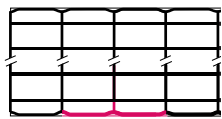

8" / 200 mm

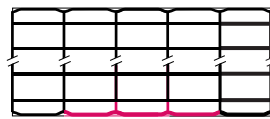

12" / 300 mm

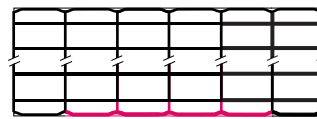

18" / 450 mm

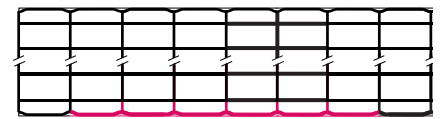

24" / 600 mm

2. Assemble the trays

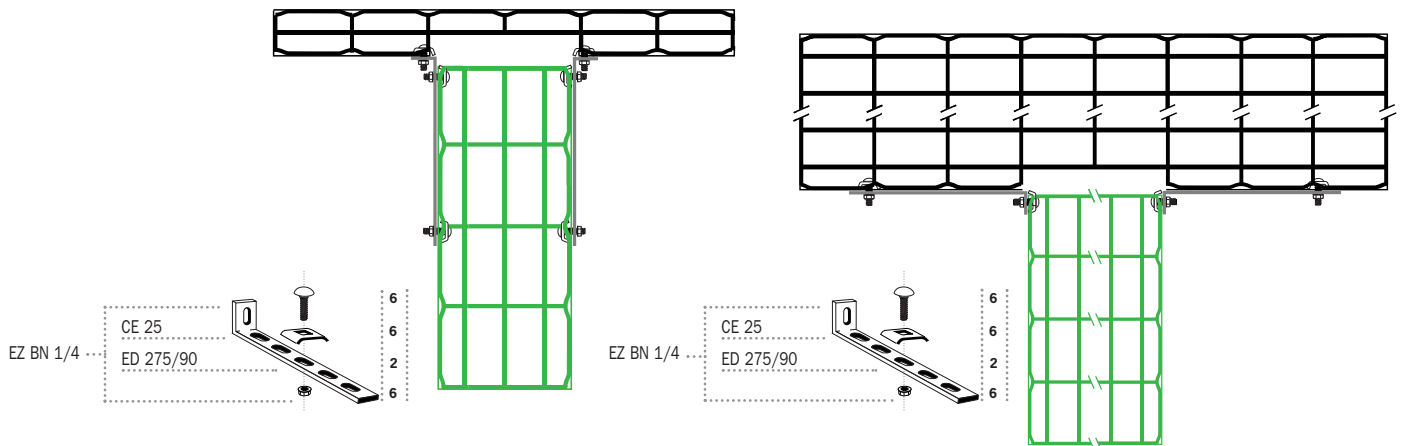

ACCESSORIES NEEDED TO FORM TRAYS

| PART # | DESCRIPTION | WEIGHT | | PACK QTY. |
|-----------|---|----------------|----------------|-----------|
| | | lb | kg | |
| EZ BN 1/4 | Round head screws with square collar and serrated nut | 1.98 (100 pcs) | 0.90 (100 pcs) | 100 |
| ED 275 | 275 mm (10") fishplate | 0.277 | 0.126 | 50 |
| ED 250/90 | T Connection Splice Bar | 0.280 | 0.126 | 50 |
| CE 25 | Counter clamp | 0.020 | 0.009 | 50 |
| CE 30 | Counter clamp | 0.033 | 0.015 | 50 |
| CE 40 | Counter clamp | 0.108 | 0.049 | 50 |



IT'S **EZ** TO FORM TEES

To form tees with a "Y" junction

1. Cut cable tray 1 & 2

Cut and remove shaded area as shown

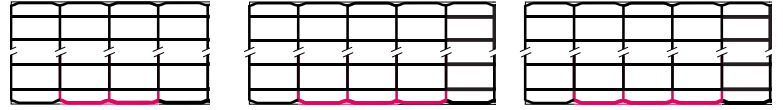

4" / 100 mm

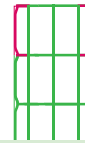

6" / 150 mm

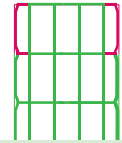

8" / 200 mm

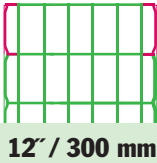
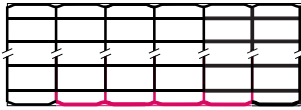

12" / 300 mm

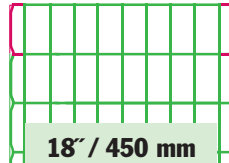
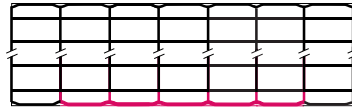

18" / 450 mm

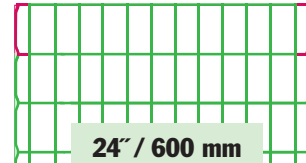
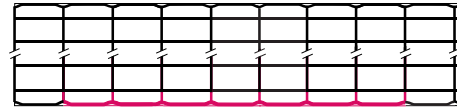

24" / 600 mm

2. Bend side wires to 45°

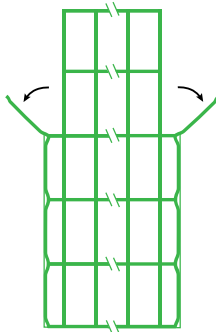
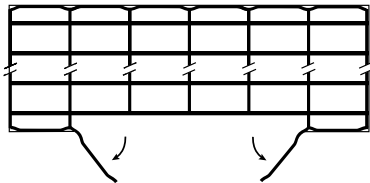

3. Assemble

WIDTH
 6" AND 18"
 150 & 450 mm

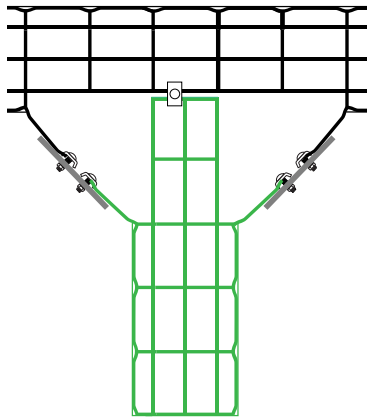

WIDTH
 4", 8" & 12"
 100, 200 & 300mm

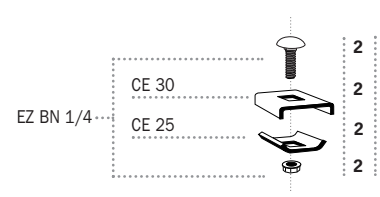
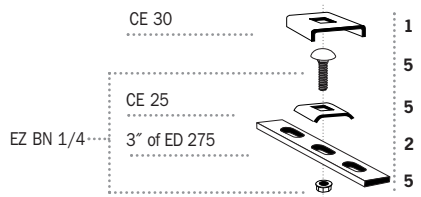
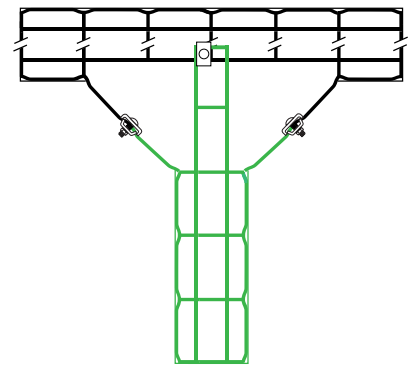

U.S. dimensions are nominal



EZTray™

IT'S EZ TO FORM REDUCTIONS AND CHANGE LEVELS

Forming Reductions

Reductions are easily made by cutting a combination of side and bottom wires as shown. Creating reductions can produce a more economical cable management system. Reductions are suggested for applications that have space limitations or require smaller cable tray.

Reduction of 4" 100 mm

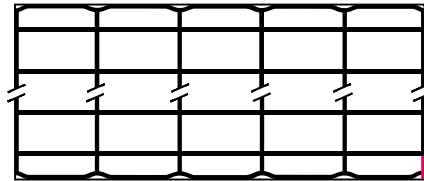

1st step

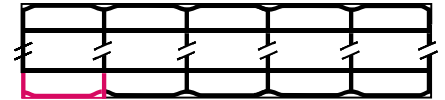

2nd step

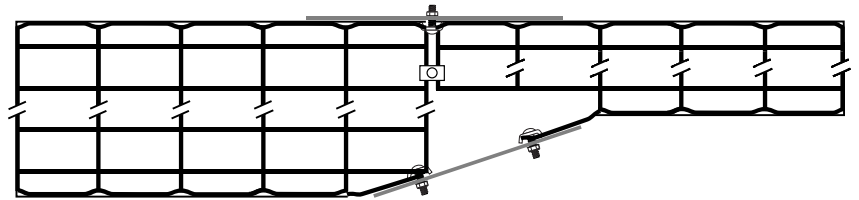
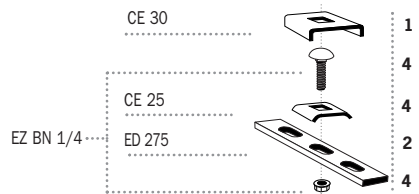

Reduction of 8" 200 mm

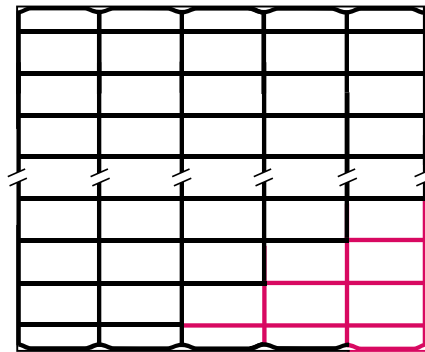

1st step

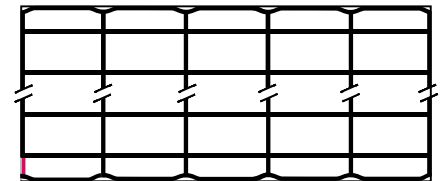

2nd step

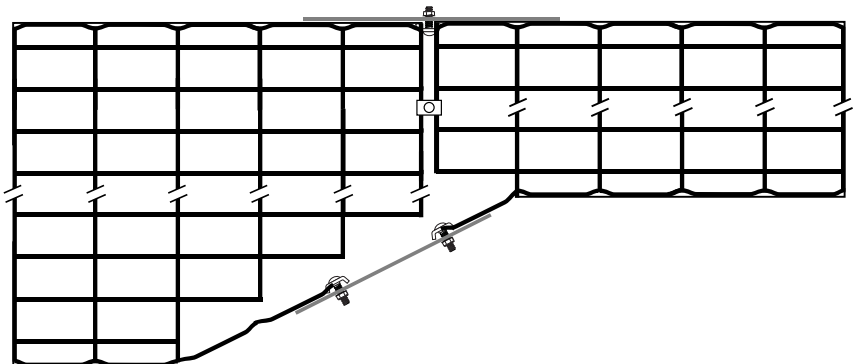
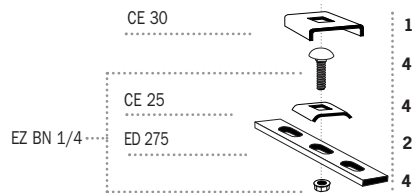

U.S. dimensions are nominal



IT'S **EZ** TO FORM REDUCTIONS AND CHANGE LEVELS

Changing Levels

To avoid obstructions, the **EZ Tray** system can easily be adapted to changing levels. Simply cut the side wires as shown and bend **EZ Tray** cable tray to the appropriate angle required.

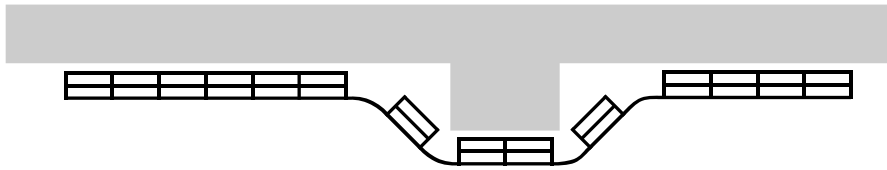
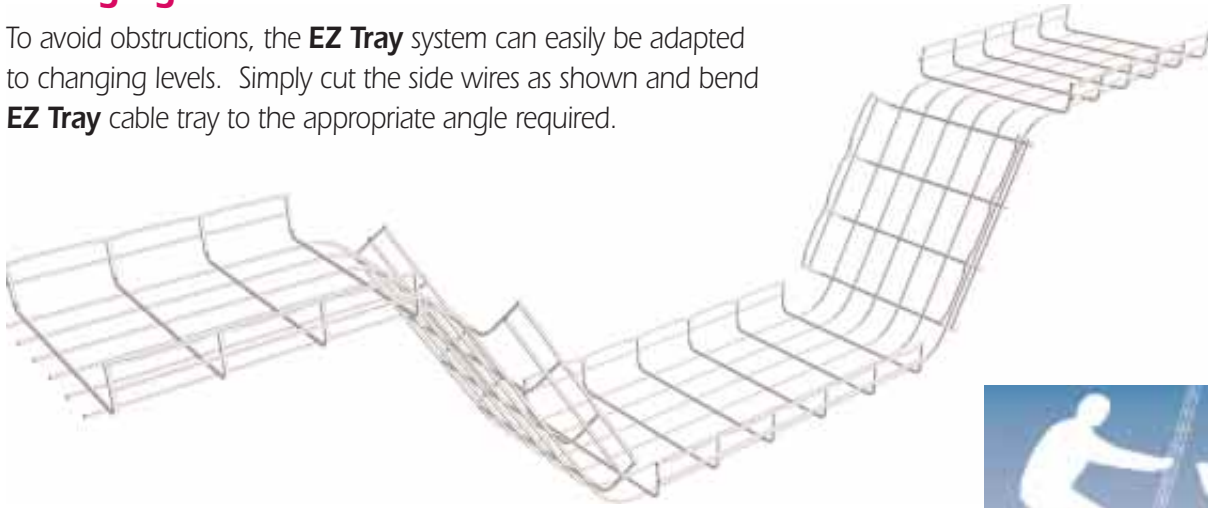

Cutting and Bending

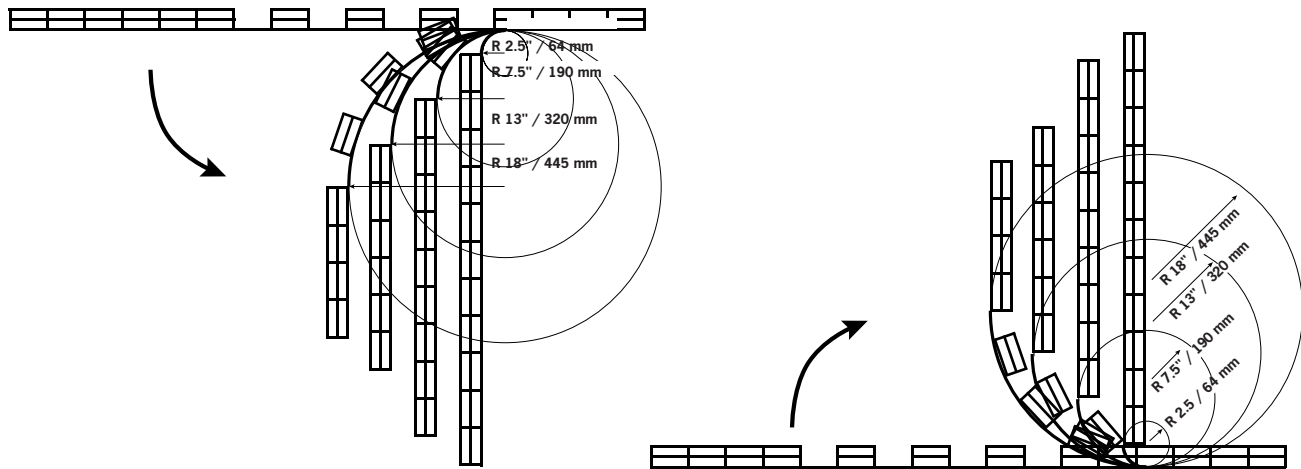

U.S. dimensions are nominal

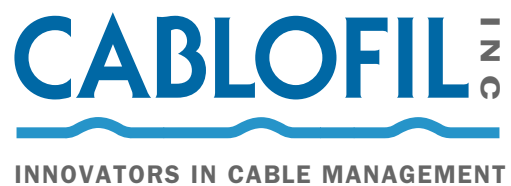

727 North First Street, Suite #240
St. Louis, MO 63102 USA
314-588-8608
800-658-4641
Fax: 314-588-8611
www.cablofil.com